



全本公示稿

.....
.....
.....
.....
.....
.....
.....
.....

1

1.1

"

682

44

<

>

1

"

61

50

"

1.2

1.3

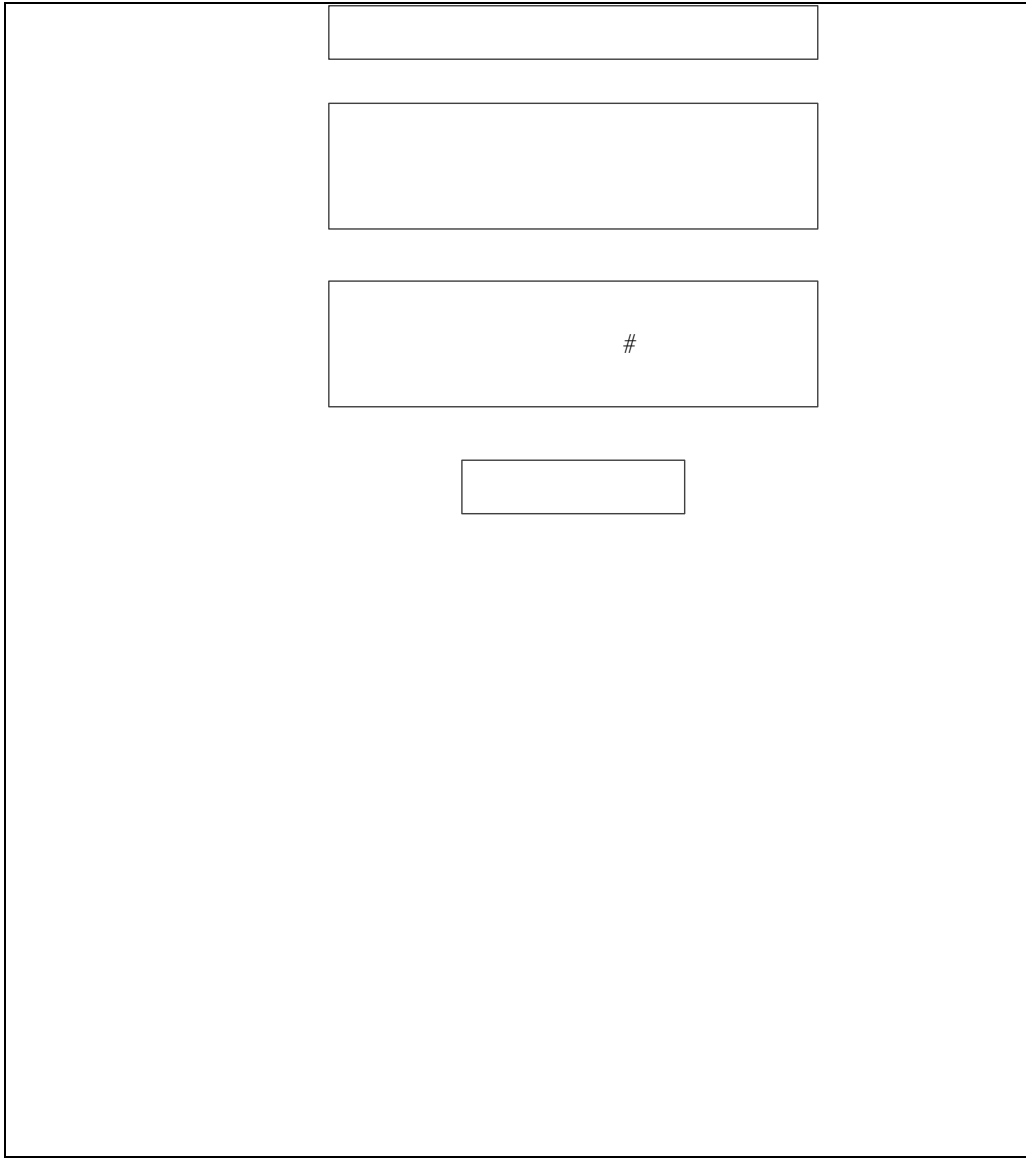

1.4

1.4.1

2019-340504-31-03-019937

1.4.2

1.4.3

1.4.4

1.4.5

1.4.6

1.4.7

VOCs		

1.4.8

1.5

1.6

“ ”

2

2.1

2.1.1

1					
2		2018	12	29	
3		2018	10	26	
4		2017	6	27	
5		2018	12	29	
6			2019	6	5
7					
8		682		2017	10 1
9		2019			
10			2012		
2012		2012	98		
11				4	2019 1
1					
12					1 2018
4	28				
13					2013 37
14					
15					
[2014]30					
16					2015 17
17	<				>
[2013]103					
18					

[2014]197

19

2.1.3

2.1.4

2.2

2.2.1



O ₃	8	160	3	HJ2.2-2018 D
NH ₃	1	200	3	
HCl	1	50		

1	pH	6~9	GB3838-2002	
2	COD	20		
3		0.05		
4	NH ₃ -N	1.0		
5	TP	0.2		
6	SS	30	SL63-94	

3	65	55	GB3096-2008

	pH	6.5 8.5	9		
			10		
			11		
			12		
			13		
			14		
	()		15		
			16		

1		60	25		0.43
2		65	26		4
3		5.7	27		270
4		18000	28	1,2-	560
5		800	29	1,4-	20
6		38	30		28
7		900	31		1290
			32		1200
8		2.8	33	+	570
9		0.9	34		640
10		37			
11	1,1-	9	35		76
12	1,2-	5	36		260
13	1,1-	66	37	2-	2256
14	-1,2-	596	38	[a]	15
15	-1,2-	54	39	[a]	1.5
16		616	40	[b]	

1			15	
			30	
2			15	
			30	
3	*		20	
4			150	
5			300	

1		5.0
2		0.2

1	pH	6~9
2	COD	70
3	SS	30
4		3
5	NH ₃ -N	5
6	TP	0.5
7	*	10

3	65	55

2.3

2.3.1.1

	1% Pmax 10%
	Pmax 1%

		PM ₁₀	450	4.0834	0.9074	/
1720		TSP	900	3.3162	0.3685	/

1%

HJ2.2-2018

HJ2.2-2018 5.3.3.2"

2.3.1.2

2.3.1.3

2.3.1.4

2.3.1.5

2.3-3

									-
								-	-
-									

2.3.1.6

				a
a				

2.3.1.7

1				5km
2				

2.4

		639456	3506032		4400	E	380	(GB3095 -2012)
		638046	3506237		620	W	920	
		637949	3505930		260	W	1050	
		637532	3505753		80	W	1530	
		638797	3505288		3800	S	815	
		638461	3504612		2620	S	1540	
		638781	3504360		160	S	1870	
		639686	3505729		340	SE	760	
		640160	3506327		1250	E	950	
		640234	3505947		2400	E	1120	
		640258	3505304		1200	SE	1380	
		640217	3504771		1600	SE	1740	
		640262	3504242		2100	SE	2160	
		641021	3507804		800	NE	2920	
		640687	3507151		2100	NE	1790	
		641035	3506652		1300	E	1870	
		640356	3506664		1150	E	1480	
		640877	3506672		800	E	1760	
		641059	3506357		2200	E	1940	
		641137	3505999		1300	E	1870	
		640596	3505963		2200	E	1510	
		640631	3505327		800	SE	2150	
		641075	3505358		1140	SE	1730	
		640646	3504765		3200	SE	1960	
		641133	3504272		2500	SE	2800	

		W	1750	(GB3838-2002)
			4.33km ²	(GB/T14848-2017)
			0.05km	(GB36600-2018)
		200m		(GB3096-2008) 3

		639456	3506032		4400	E	380
		638046	3506237		620	W	920
		637949	3505930		260	W	1050
		637532	3505753		80	W	1530
		638797	3505288		3800	S	815
		638461	3504612		2620	S	1540
		638781	3504360		160	S	1870
		639686	3505729		340	SE	760
		640160	3506327		1250	E	950
		640234	3505947		2400	E	1120
		640258	3505304		1200	SE	1380
		640217	3504771		1600	SE	1740
		640262	3504242		2100	SE	2160
		641021	3507804		800	NE	2920
		640687	3507151		2100	NE	1790
		641035	3506652		1300	E	1870
		640356	3506664		1150	E	1480
		640877	3506672		800	E	1760
		641059	3506357		2200	E	1940
		641137	3505999		1300	E	1870
		640596	3505963		2200	E	1510
		640631	3505327		800	SE	2150
		641075	3505358		1140	SE	1730
		640646	3504765		3200	SE	1960
		641133	3504272		2500	SE	2800
		640673	3503717		680	SE	2900
		640250	3503597		800	SE	2810
		638765	3503297		2800	S	2870
		639138	3502566		220	S	3590
		639278	3501690		130	S	4500
		636928	3501707		40	SW	3920
		634921	3503205		80	SW	4800
		640411	3510761		720	N	4800

(GB3095-2012)

2.5

2.5.1

3

3.1

3.1.1

%

h &
- \$ h

%t & \$

h



3.1.2

3.1.3

	CQ	106.96
	DQ	19.86
	DDQ	15.28
	HSLA	10.70
		152.8

3.1.4

	1720	1720	-					7530m ²	1
							152.8	t	
							1800m ²		1
									18m ³ /min
		1720							
							8.5m ³ /h		
									1200m ²
							5400m ²		
							3900m ²		
							200m ²		
							1200m ²	10	2
		1	150m ³		2	150m ³	60m ³	2	150m ³
		150m ³		150m ³	40m ³	150m ³			
									3000m ³
							25m ³ /h		
			301						1560m ³ /h
									20m ³ /h
									8m ³ /d
							2		7800 kWh
								6.5t/h	80
									6450m ³ /h
									1200m ³ /h

1# 2#	39m	4×28t	2
	/		1
	/		1
1# 2#	/		2
	/		2
	/		2
	/		2
		1m	1
		NMW-C	1
	/		2
	/		1
3#	4		1
			1
	/		6
	/		8
	/		1
		45t	1
	122m	1.45m	1
	18m	1.95m 2.8m	1
	5m	2.3m 1.6m	1
	/		1
		780MPa	1
		188mm	1
	/		1
	1#-4#	UCM	1
	/		1
	/		1
	/		2
	/		2
	/		1
	/		1
	/		1

3.1.7

3.1.7.1

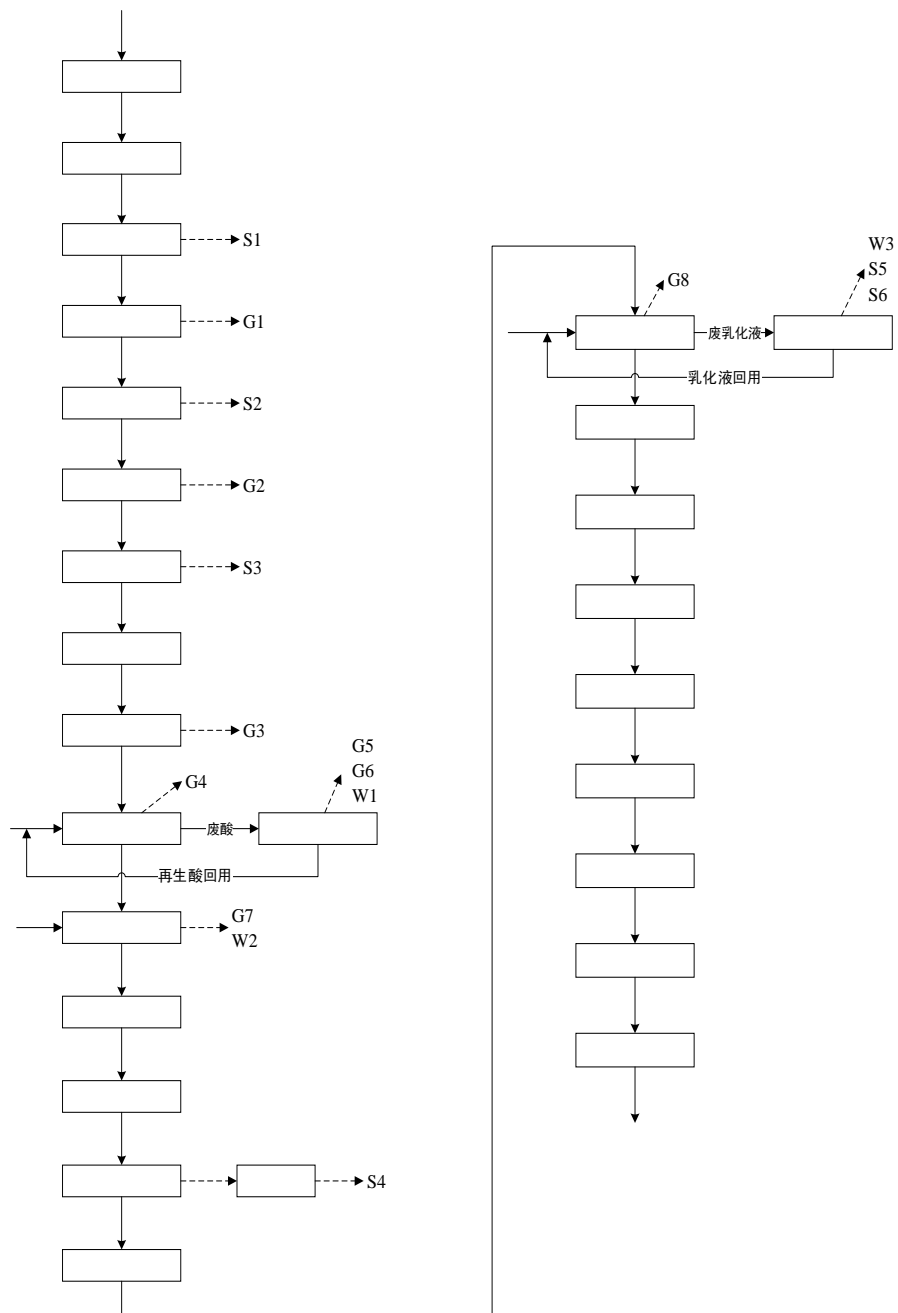

3.1.7.2

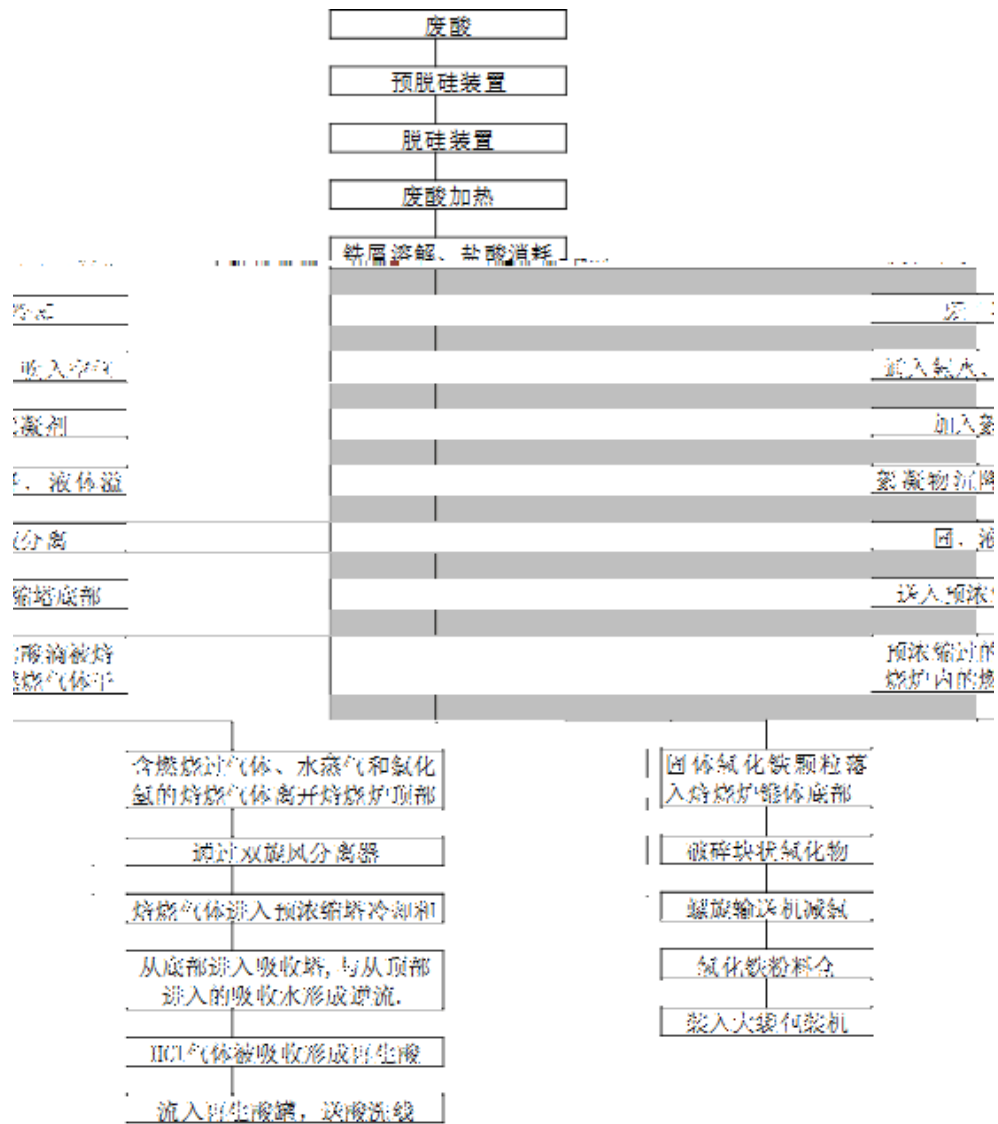

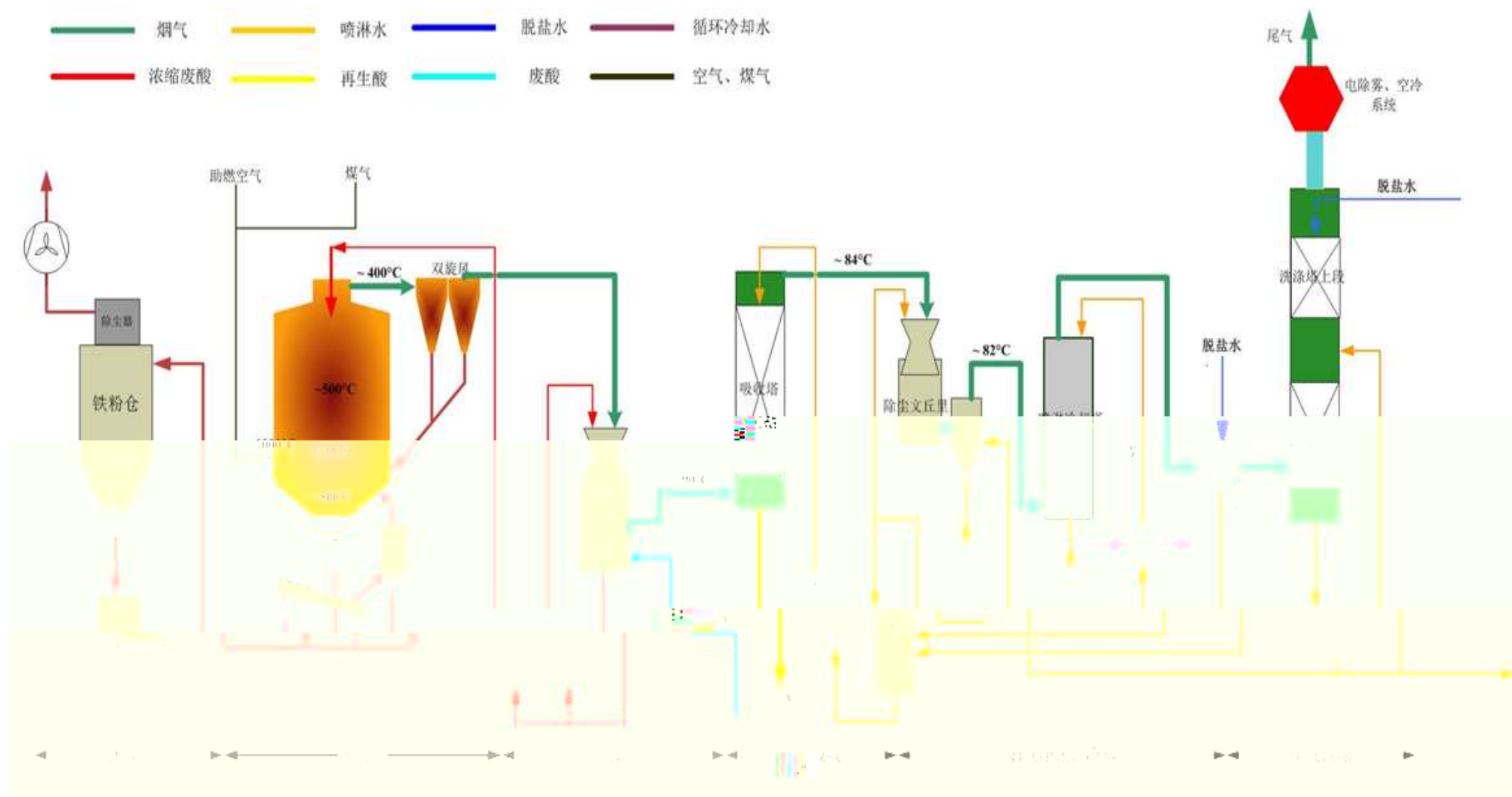



3.2

3.2.1

3.2.1.1

			HCl	+30m
				+27m
			HCl SO ₂ NO _x	+ +40m
				+12m

3.2.1.2

		2019.3.28		14940	9.42
				16597	10.9
				12744	8.12

		2019.9.5		18314	2.8	18.7
				18283	3.9	20.9
				18987	3.4	20.7

		2019.5.28		9751	7.8
				9288	8.4
				9012	5.6

		0.292~0.324	0.383~0.416	0.331~0.367	5.0
2019.10.11~ 10.12		0.07~0.12	0.08~0.17	0.10~0.14	

3.2.1.3

		/	0.02S		0.02S
		/	8.6		8.6

4#

1#		1.5	HCl	12.1	0.181	1.412
2#		24		5.3	1.066	8.316
3#		1.9	HCl	20.7	0.393	3.065
				3.8	0.071	0.556
			SO ₂	35.7	0.678	5.29
			NO _x	40.7	0.774	6.038
4#		1		7.8	0.078	0.608



				M	P (Pa)	D (m)	H (m)	ΔT ()	F _P	C	K _c	K _N
32%	2	150m ³		36.46	3133	6	5.6	12	1.25	0.88 93	1	1
		60m ³				4.2	4.5					
18%	2	150m ³	80	36.46	1146	6	5.6	12	1.25	0.88 93	1	0.2 7
25%	1	40m ³		35.05	1590	3.6	4.2	12	1.25	0.58 62	1	1

1		1720		2.74	24
2				0.192	1.68
3				0.010	0.084
4				0.017	0.15
5			HCl	0.046	0.402
6			NH ₃	0.003	0.027

3.2.2

			pH COD SS	301
			COD SS NH ₃ -N	

301	2018-10-30	pH	7.27	6~9
		COD	33	70
			8	30
			1	5
			0.06	3

			288m ³ /d		301
		pH	2~4		
		COD	1500	0.432	
		SS	800	0.230	
			2000	0.576	
			192m ³ /d		
		COD	8000	1.536	
		SS	3000	0.576	
			15000	2.88	
			8m ³ /d		
		COD	350	0.003	
		NH ₃ -N	25	0.0002	
		SS	250	0.002	

3.2.3

20~25dB(A)

3.2.4

GB34330-2017

2016

1			62000		
2			10000		
3			18.25		

1		HW08	320					3	T I	
2		HW49	150						T/In	
3		HW49	2.5						T/In	
4		HW08	25						T I	
5		HW49	0.5						T/In	
5		HW17	800						T/C	

3.2.5

		HCl	4.477
			8.316
			1.164
		SO ₂	5.29
		NO _x	6.038
			16.834
			1.68
		HCl	0.402
		NH ₃	0.027
			0 480m ³ /d
			0 8m ³ /d
			0 1273
			0 72000
			0 18.25

3.3

4

4.1

4.1.1

4.1.2

CQ	106.96	77.2	/
DQ	19.86	15.0	/
DDQ	15.28	12.0	/
HSLA	10.70	16.0	340
DP	/	5.0	590 TS 780
	/	27.0	50W1300/50W800/50W600/50W470
	152.8	152.8	/

0.3~2.5mm	900~1575mm	610mm	Max.1900mm
Max.28.35t	CQ HSLA	DQ DP	DDQ

	1600000t	1528000t	72000t	95.5%	

4.1.3

	1720	7530m ²	1 1720 -	152.8 t
				1720
				1# 2# 3#
		1800m ²	1	18m ³ /min
				/
		1720		8.5m ³ /h
				/
				1200m ²
				/
				5400m ²
				/
				3900m ²
				/
				200m ²
				/
				3000m ³
				/
				25m ³ /h
				/
			301	1560m ³ /h
				273m ³ /h
				1833m ³ /h
				/
				20m ³ /h
				/

		8m ³ /d	
	2	7800 kWh	1500 kWh 9300 kWh
		6.5t/h 80	/
		6450m ³ /h	660m ³ /h 7110m ³ /h
		1200m ³ /h	/
		+ +30m	/
		+ +27m	/
		+ + +40m + +12m 1 1	/
		+	
			+25m +
		301	/
			/

4.1.4



--	--	--	--	--	--

4.1.5

1# 2#	39m 4x28t	2		39m 4x28t	2	
3#	4	1		4	1	
	122m 1.45m	1		122m 1.45m	1	6 IBOX
	1#-4# UCM	1		1#-2# UCMW 3# HYPER UC-MILL 4# UCM	1	1#~3#
	NMW-C	1		C	1	
		1			1	
				/	1	
					1	
				/	2	
				6mm	1	
					1	
				/	1	
				/	2	
				5m ³	4	
				40m ³	1	
		6			6	
	R340mm	1		R340mm	1	
1#		1			1	
	5m 2.3m 1.6m	1		5m 2.3m 1.6m	1	
	/	1		/	1	
		1		188mm	1	
	/	1		/	1	
	/	1		/	1	
1# 2#	/	2		/	2	
	/	2		/	2	
	/	2		/	2	
	/	2		/	2	
	/	2		/	2	

	1m	1		1m	1	
	/	2		/	2	
	/	1		/	1	
	/	8		/	8	
	/	1		/	1	
	18m	1		18m	1	
	/	1		/	1	
	/	1		/	1	
	/	1		/	1	
	/	1		/	1	
	/	2		/	2	
	/	2		/	2	
	/	1		/	1	
	/	1		/	1	
		1			1	

4.1.6

4.1.7

4.2

4.2.1

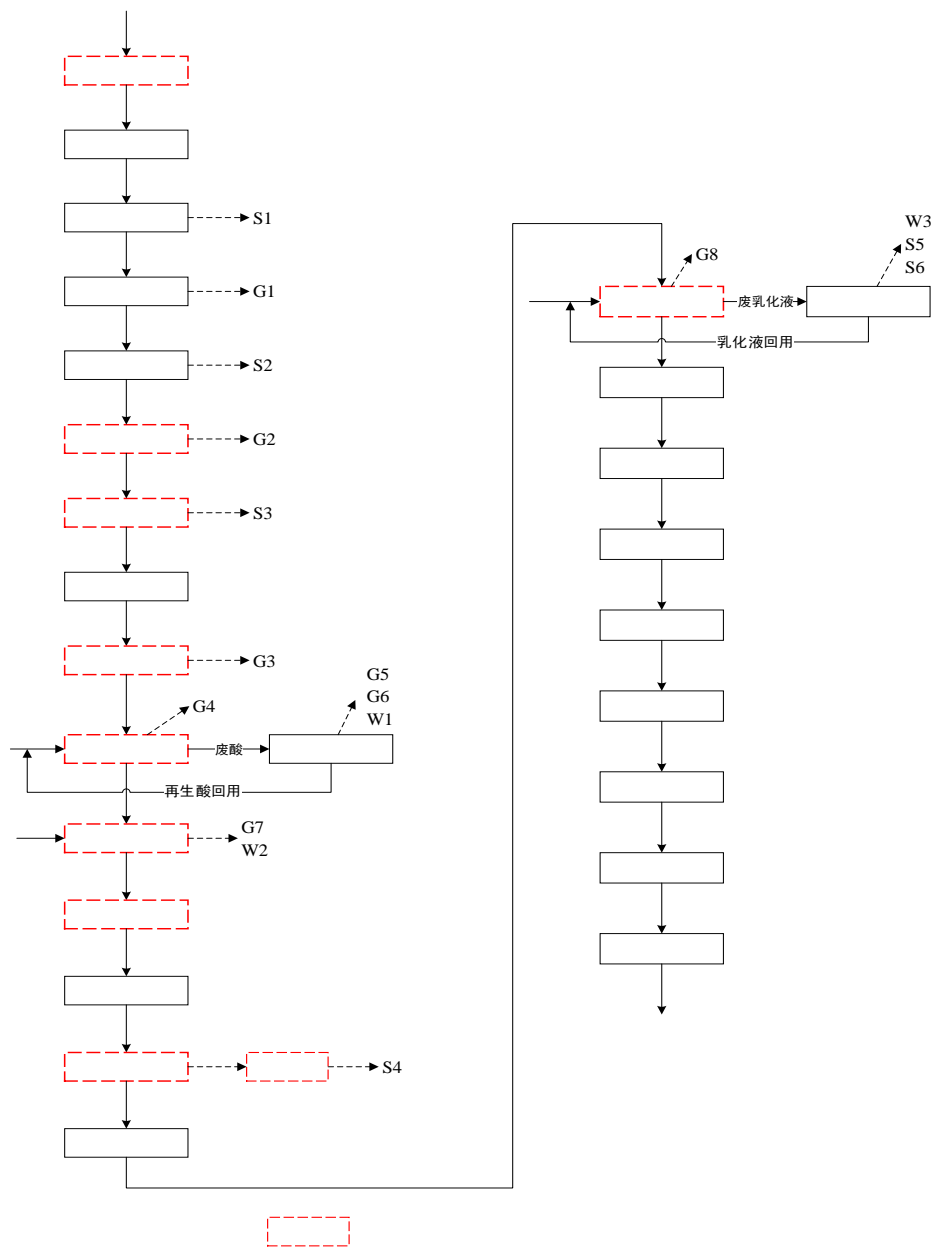



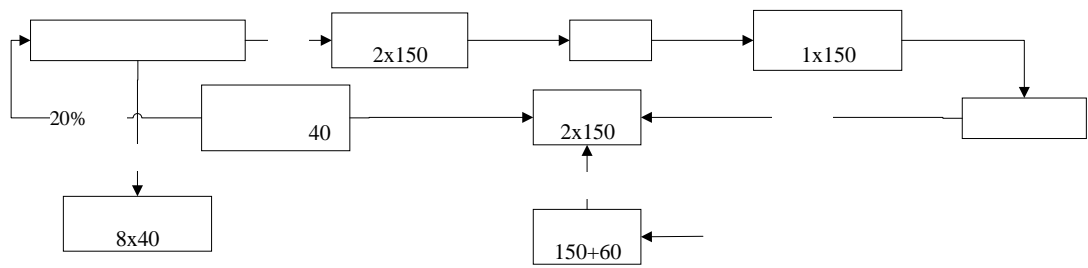





× ×



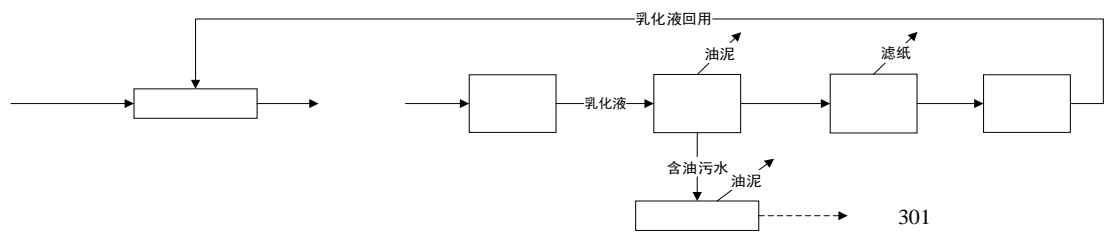



4.2.1.1

	G ₁			
	G ₂			
	G ₃			
	G ₄ G ₇			HCl
	G ₅			HCl SO ₂ NO _x
	G ₆			
	G ₈			
		W ₁		
W ₂				
W ₃				COD
	S ₁ ~S ₄			
	S ₅			
	S ₆			

4.2.2

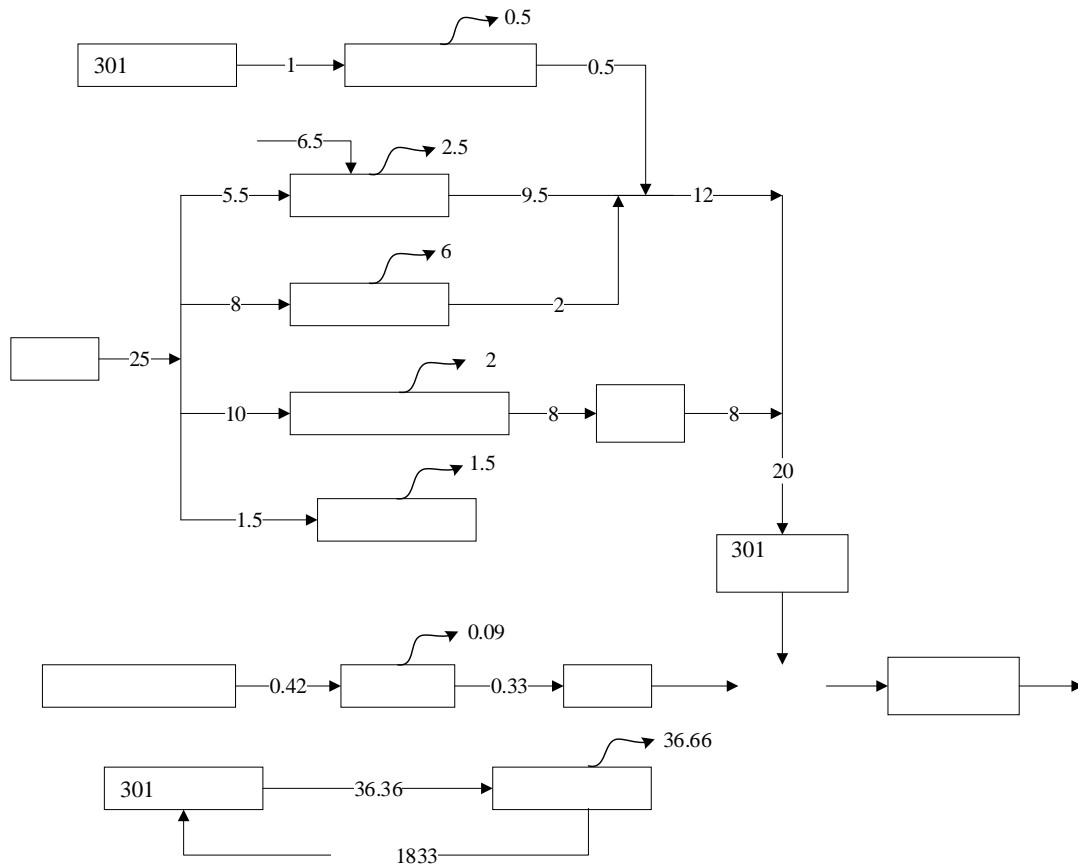

4.3

4.3.1

4.3.1.1

1

	10		203.07	20.307	158.4		99.6 %	0.8	0.081	0.634	25 m

4.3.1.2

1#		HCl	1.412
2#			8.316
3#		HCl	3.065
			0.556
		SO ₂	5.29
		NO _x	6.038
4#			0.608
5#			0.634

1			0.02
2			0.24
3			0.75
4			1.68
5		HCl	0.402
6		NH ₃	0.027

4.3.2

			288m ³ /d		301
		pH	2~4		
		COD	1500	0.432	
		SS	800	0.230	
			2000	0.576	
			192m ³ /d		
		COD	8000	1.536	
		SS	3000	0.576	
			15000	2.88	
			8m ³ /d		
		COD	350	0.003	
		NH ₃ -N	25	0.0002	
		SS	250	0.002	

4.3.3

4.3.4

1			62000		
2			10000		
3	/		18.25		
4			320		
5			150		
6			2.5		
7			25		
8			0.5		
9			800		

4.3.5

4.3.5.1

		158.4	157.766	0.634

4.3.5.2

		HCl	1.412	
			8.316	
		HCl	3.065	
			0.556	
		SO ₂	5.29	
		NO _x	6.038	
			0.608	
			0.634	
			0.24	" "
			0.02	
			1.68	
			0.75	
		HCl	0.402	
		NH ₃	0.027	
		COD	0	
		NH ₃ -N	0	
			0	
			0	

4.3.5.3 "

					" "
			16	0.24	15.76
			0.084	0.02	0.064
			16.084	0.26	15.824

4.3.6

" "

4.3-9

t/a

	HCl	4.477	0	0	4.477	0
		8.316	0	0	8.316	0
		1.164	0.634	0	1.798	+0.634
	SO ₂	5.29	0	0	5.29	0
	NOx	6.038	0	0	6.038	0
		16.834	0	15.824	1.01	-15.824
		1.68	0	0	1.68	0
	HCl	0.402	0	0	0.402	0
	NH ₃	0.027	0	0	0.027	0
		0 8m ³ /d	0	0	0	0
		0 480m ³ /d	0	0	0	0
		0 72000	0	0	0	0
		0 1273	0	0	0	0
		0 18.25	0	0	0	0

4.4

4.4.1

4.4.2

4.4.3

4.4.4

5

5.1

5.1.1

-
-

-
-

5.1.2

10m

150-250m

458.9m

120m

15-60m

5.1.4

5.1.5

5.1.7

5.2

5.2.1

1			GB3095-2012
2			GB3838-2002
3		3	GB3096-2008

5.2.2

5.3

5.3.1

5.3.1.1

2018		AQI	27	265		
57		200			71.4%	
		5.8		PM _{2.5}	45	
/				10.0%	PM ₁₀	
75	/				9.6%	
15	/				11.8%	
	37	/			5.1%	
95		1.7	/			
5.6%	8		90	183	/	
		2.7%		3.90%	pH	6.11

SO ₂		15	60	0	
NO ₂		37	40	0	
PM ₁₀		75	70	0.07	
PM _{2.5}		45	35	0.29	
CO	95	1700	4000	0	
O ₃	8 90	183	160	0.14	

5.3.1.2

G1	SO ₂	7	15	0	0.03	9	13	0	0.09
	NO ₂	14	35	0	0.18	23	26	0	0.33
	PM _{2.5}	/	/	/	/	48	60	0	0.80
	PM ₁₀	/	/	/	/	81	89	0	0.59
	TSP	/	/	/	/	118	124	0	0.41
	HCl	20	20	0	0.40	/	/	/	/
	NH ₃	10	30	0	0.15	/	/	/	/
G2	SO ₂	8	20	0	0.04	12	15	0	0.10
	NO ₂	15	37		0.19	24	28	0	0.35
	PM _{2.5}	/	/	/	/	47	60	0	0.80
	PM ₁₀	/	/	/	/	80	90	0	0.60
	TSP	/	/	/	/	117	124	0	0.41
	HCl	20	20	0	0.40	/	/	/	/
	NH ₃	30	60	0	0.30	/	/	/	/

5.3.2

W1		500m		pH COD NH ₃ -N SS TP
W2		1000m		
W3		2500m		

d

d

$$S_{\text{pH}_j} = \frac{7.0 - \text{pH}_j}{7.0 - \text{pH}_{\text{sd}}} \quad \text{pH}_j \leq 7.0$$

$$S_{\text{pH}_j} = \frac{\text{pH}_j - 7.0}{\text{pH}_{\text{su}} - 7.0} \quad \text{pH}_j > 7.0$$

W1		7.15	10	0.47	13	0.04	0.02	22.1
		7.26	12	0.49	14	0.05	0.04	23.7
		7.21	11.00	0.48	13.50	0.045	0.03	22.90
		0.10	0.55	0.48	0.45	0.225	0.6	/
	(%)	0	0	0	0	0	0	/
W2		7.19	15	0.53	16	0.07	0.02	24.2
		7.24	16	0.56	18	0.08	0.04	25.1
		7.22	15.50	0.55	17.00	0.075	0.03	24.65
		0.11	0.78	0.55	0.57	0.38	0.60	/
	(%)	0	0	0	0	0	0	/
W3		7.20	12	0.50	14	0.05	0.02	22.3
		7.24	14	0.52	16	0.08	0.03	23.4
		7.22	13.00	0.51	15.00	0.07	0.03	22.85
		0.11	0.65	0.51	0.50	0.33	0.50	/
	(%)	0	0	0	0	0	0	/

5.3.3



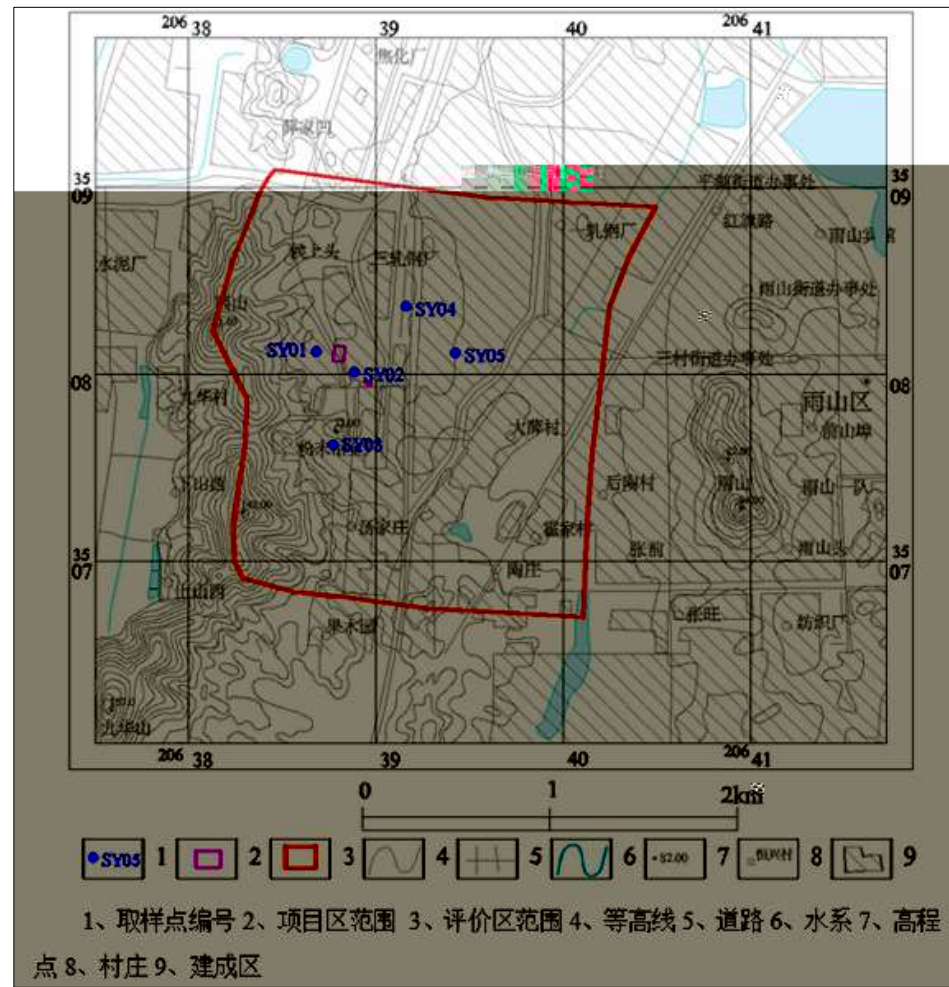
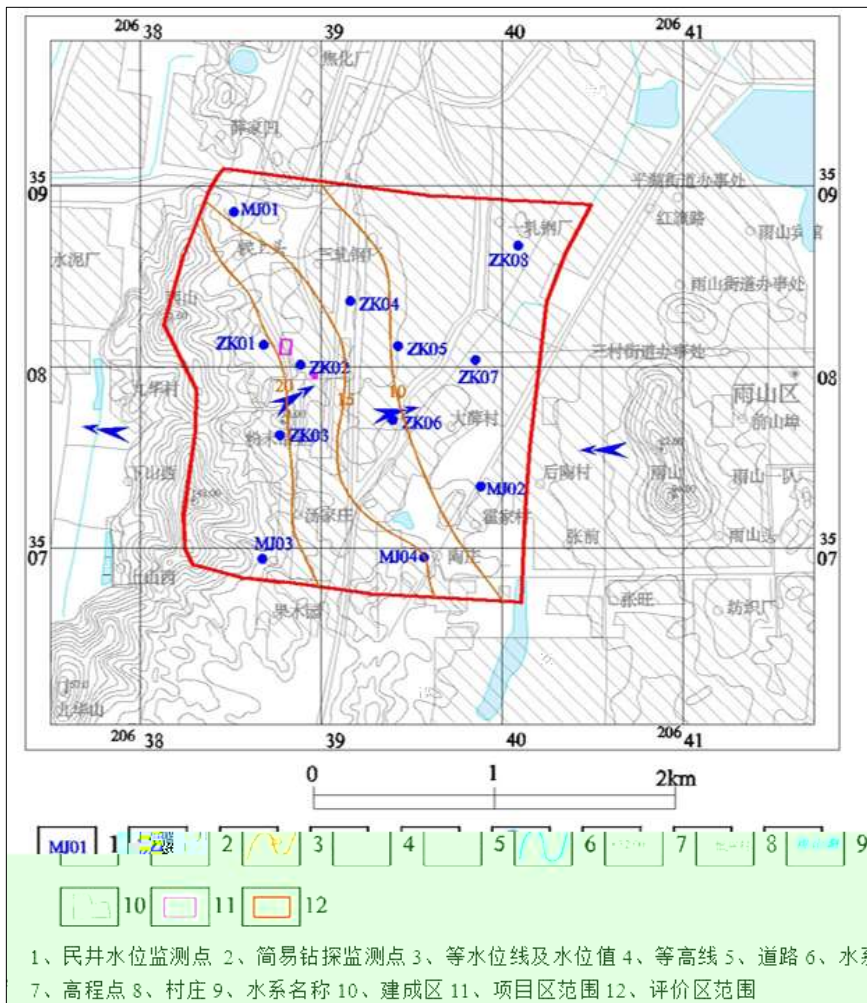

SY01			10	
SY02		-	10	
SY03			10	
SY04			10	
SY05			10	

MJ01	20638467.11	3508987.12	12.5	5		1.1	11.4
MJ02	20639831.76	3507356.43	9.8	6		1.5	8.3
MJ03	20638677.16	3506965.45	24.6	8.0		2.8	21.8
MJ04	20639518.78	3506961.95	16.6	8.0		1.5	15.1
ZK01	20638626.95	3508124.13	22.6	10.0		2	20.6
ZK02	20638833.60	3508025.07	18.9	10.0		2	16.9
ZK03	20638713.82	3507580.02	22.5	10.0		1.8	20.7
ZK04	20639113.83	3508369.05	15.8	10.0		1.6	14.2
ZK05	20639368.57	3508122.29	10.5	10.0		1.3	9.2
ZK06	20639345.39	3507717.21	11.5	10.0		1.2	10.3
ZK07	20639805.30	3508053.08	8.9	10.0		1.3	7.6
ZK08	20640039.97	3508682.16	8.0	10.0		1.2	6.8

SY01	7.36	281.36	36.12	0.046	4.14	0.18	56.39	0.21	0.00089	<0.004	0.00082	<0.0001	0.00215	0.00652	2.61	<0.002	471	0.045	
SY02	7.50	287.23	72.08	0.05	0.946	<0.04	82.63	0.21	<0.0005	<0.004	0.00053	<0.0001	0.00315	0.00122	1.70	<0.002	516	0.038	
SY03	7.49	127.41	54.07	0.032	0.402	0.19	38.87	0.34	<0.0005	0.0073	0.00050	<0.0001	0.00841	0.0032	2.56	<0.002	255	0.04	
SY04	7.45	153.14	55.06	0.004	0.395	0.15	42.19	0.32	<0.0005	0.0063	0.00030	<0.0001	0.00072	0.0028	2.21	<0.002	270	0.018	
SY05	7.48	139.03	50.06	0.004	0.361	0.15	40.19	0.32	<0.0005	<0.004	0.00078	<0.0001	0.0012	0.0035	1.84	<0.002	250	0.025	
	6.5~8.5												0.01	0.01	3.0		1000	0.05	

SY01	0.24																		
SY02	0.33																		
SY03	0.33																		
SY04	0.30																		
SY05	0.32																		

5.3.4

A

N1		55.2	54.5	65	
N2		54.1	53.8		
N3		54.6	54.0		
N4		55.0	54.2		
N5		55.5	54.7		
N1		45.3	44.4	55	
N2		44.5	44.0		
N3		44.7	44.1		
N4		45.1	44.3		
N5		45.6	44.6		

GB3096-2008

3

5.3.5

pH	6.84	6.90	6.88	/
	89	84	79	4500
mg/kg				
	18.2	18.5	17.6	60
	0.19	0.16	0.14	65
	3.96	3.58	3.88	5.7
	36	33	37	2000
	34.8	33.2	35.7	400
	0.0300	0.0384	0.0327	38
	46	38	43	900
	<1.3	<1.3	<1.3	2.8
	<1.1	<1.1	<1.1	0.9
	<1.0	<1.0	<1.0	37
1,1-	<1.2	<1.2	<1.2	9
1,2-	<1.3	<1.3	<1.3	5
1,1-	<1.2	<1.2	<1.2	66
-1,2-	<1.3	<1.3	<1.3	596
-1,2-	<1.4	<1.4	<1.4	54
	<1.5	<1.5	<1.5	616
1,2	<1.1	<1.1	<1.1	5
1,1,1,2-	<1.2	<1.2	<1.2	10
1,1,2,2-	<1.2	<1.2	<1.2	6.8
	<1.4	<1.4	<1.4	53
1,1,1-	<1.3	<1.3	<1.3	840
1,1,2-	<1.2	<1.2	<1.2	2.8
	<1.2	<1.2	<1.2	2.8

1,2,3-	<1.2	<1.2	<1.2	0.5
	<1.0	<1.0	<1.0	0.43
	<1.9	<1.9	<1.9	4
	<1.2	<1.2	<1.2	270
1,2-	<1.5	<1.5	<1.5	560
1,4-	<1.5	<1.5	<1.5	20
	<1.2	<1.2	<1.2	28
	<1.1	<1.1	<1.1	1290
	<1.3	<1.3	<1.3	1200
+	<1.2	<1.2	<1.2	570
	<1.2	<1.2	<1.2	640
mg/kg				
	<0.09	<0.09	<0.09	76
	<0.06	<0.06	<0.06	260
2-	<1.2	<1.2	<1.2	2256
[a]	<0.1	<0.1	<0.1	15
[a]	<0.1	<0.1	<0.1	1.5
[b]	<0.2	<0.2	<0.2	15
[k]	<0.1	<0.1	<0.1	151
	<0.1			

-1,2-	ND	ND	ND
	ND	ND	ND
1,2	ND	ND	ND
1,1,1,2-	ND	ND	ND
1,1,2,2-	ND	ND	ND
	ND	ND	ND
1,1,1-	ND	ND	ND
1,1,2-	ND	ND	ND
	ND	ND	ND
1,2,3-	ND	ND	ND
	ND	ND	ND
	ND	ND	ND
	ND	ND	ND
1,2-	ND	ND	ND
1,4-	ND	ND	ND
	ND	ND	ND
	ND	ND	ND
	ND	ND	ND
+	ND	ND	ND
	ND	ND	ND
	ND	ND	ND
	ND	ND	ND
2-	ND	ND	ND
[a]	ND	ND	ND
[a]	ND	ND	ND
[b]	ND	ND	ND
[k]	ND	ND	ND
	ND	ND	ND
[a h]	ND	ND	ND
[1 2 3-c d]	ND	ND	ND
	ND	ND	ND

6

6.1

6.2

6.2.1

6.2.1.1

	16.9		
	38.1	2013-08-11	42.0
	-6.1	2016-01-24	-10.3
hPa	1011.6		
hPa	15.8		
%	72.5		
mm	1148.8		



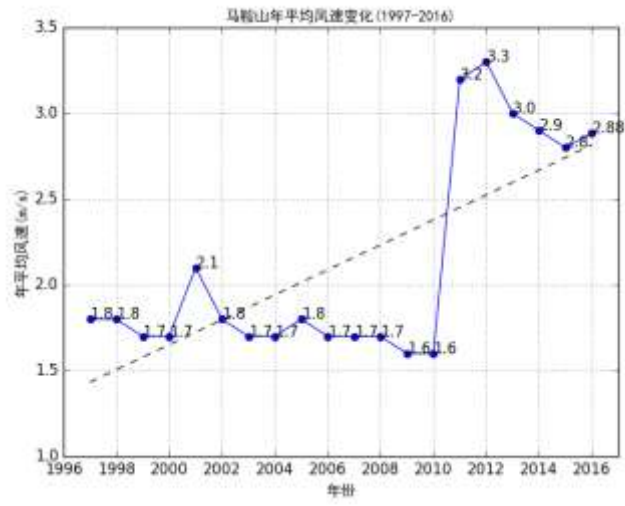

6.2.2

	639118	3506426	18	25	1.5	17.2	25	7800	0.081

	639118	3506426	18	25	1.5	17.2	25	7800	20.307

1720	639066	3506292	18	320	30	20	8760		0.03

6.2.3

6.2.3.1

6.2.3.2

6.2.3.3

/	/	
		229.3
	/	42.0
	/	-10.3
	/m	90

6.2.3.4

		PM ₁₀	450	4.0834	0.9074	/
1720		TSP	900	3.3162	0.3685	/

1%

HJ2.2-2018

6.2.4

6.2.4.1

1	1#		0.8	0.081	0.634

1		0.634

1#				101.54	10.154	1h	2	

6.2.5

6.2.6

6.2.7

6.2.8

			5	=5 km
	SO ₂ +NO _x		500 ~	500 t/a
		HCl NH ₃ TSP		PM _{2.5} PM _{2.5}
				D
			2018	
			5 50km	
				PM _{2.5} PM _{2.5}
			C	C
			C	C
			C	C
	1h		h C	C
			C	C
			k -	k -

		m		
		SO ₂ : t/a	: 0.634 t/a	VOCs: t/a

6.3

6.3.1

6.3.2

6.3.3

		pH	
		A B	
		km	km

		III	
		km	km

				t a	mg L
				t a	mg L
		$m^3 s$	$m^3 s$	$m^3 s$	
		m	m	m	

6.4

6.5

6.5.1

2016

1		/	62000	
2		/	10000	
3		/	18.25	
4		HW08	320	
5		HW49	150	
6		HW49	2.5	
7		HW08	25	
8		HW49	0.5	
9		HW17	800	

6.5.2

6.5.3

“ ”

6.6

6.6.1

6.6.1.1

• •



•

•

•

•

•

•

•

•

6.6.1.2

6.6.2

6.7

6.7.1

6.7.2

6.8

					LC ₅₀
--	--	--	--	--	------------------

6.8.1.2

6.8.2

6.8.2.1

$$Q = \frac{q_1}{Q_1} + \frac{q_2}{Q_2} + \dots + \frac{q_n}{Q_n}$$

..... ---

..... ---

1	25%	1336-21-6	36	10	3.6
2		/	15	2500	0.006
3	20%~32%	7647-01-0	708	/	/
					3.606

		10/
		5/
	a	5/
/	/	10
	b	10
		5
a	b 300	P 10.0MPa

Q 100	P1	P1	P2	P3
10 Q 100	P1	P2	P3	P4
1 Q 10	P2	P3	P4	P4

6.8.2.2

E1	5km 5 1000			500m 200m 200	
E2	5km 1 1000	5		500m 200m 100	500
E3	5km 1		500m 200m	500	100

F1	24h
F2	24h
F3	

S1	10km
S2	10km

S3	10km 1 2

S1	E1	E1	E2
S2	E1	E2	E3
S3	E1	E2	E3

G1	
G2	
G3	

D3	$^{-6}\text{cm/s}$
D2	1.0m $^{-6}\text{cm/s}$ $1 \times 10^{-6}\text{cm/s}$ $^{-4}\text{cm/s}$
D1	D2 D3

G1	

G2	
G3	

D1	E1	E1	E2
D2	E1	E2	E3
D3	E2	E3	E3

6.8.2.3

E1	IV+	IV		
E2	IV			
E3				

6.8.3

6.8.4

6.8.5

6.8.5.1

×

6.8.5.2

$$Q_L = C_d A \rho \sqrt{\frac{2(P - P_0)}{\rho} + 2gh}$$

6.8.6

1	90	2.4524E+01
3	120	2.4524E+01
5	120	2.6719E+01
7	120	2.6719E+01
9	120	2.6719E+01
11	120	2.6719E+01
13	120	2.6719E+01
15	120	2.6719E+01
17	120	2.6719E+01
19	120	2.6719E+01
21	120	2.6719E+01
23	120	2.6719E+01
25	120	2.6719E+01
27	120	2.6719E+01
29	120	2.6719E+01

HCl	26.719	120	150		33

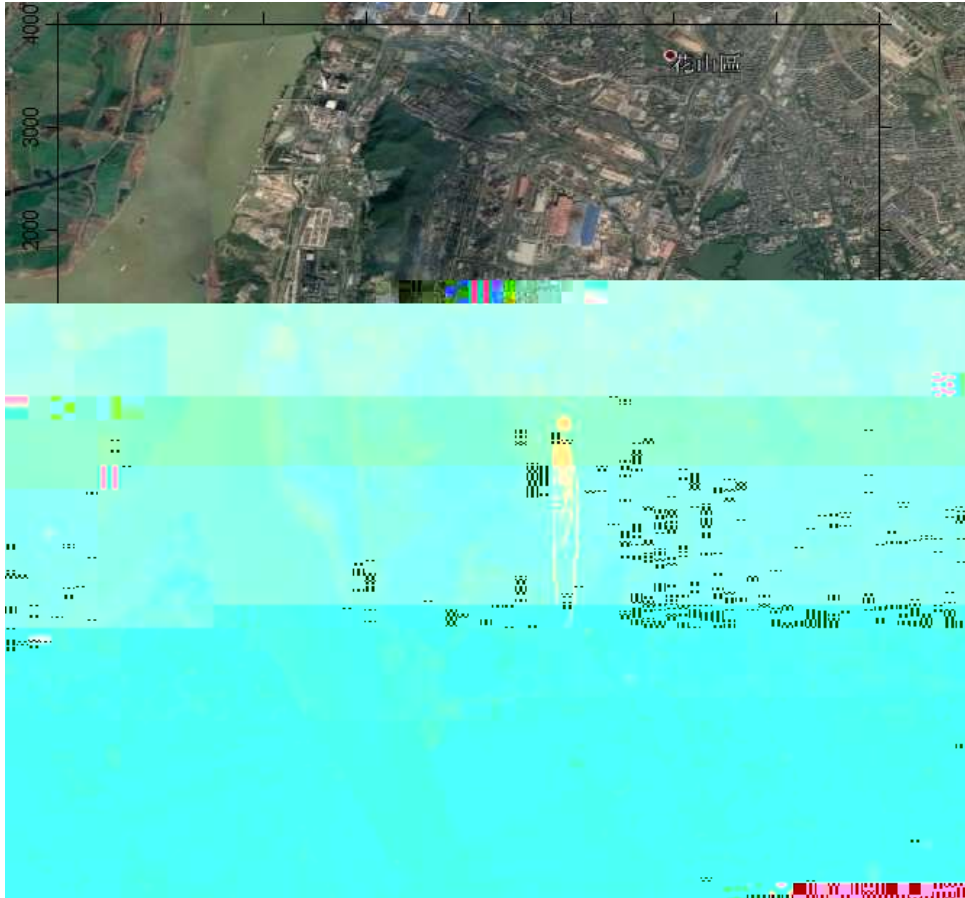

6.8.7

\

6.8.7.1

6.8.7.2

6.8.9

6.8.10

			_____		_____			
			_____					_____

7

7.1

7.1.1

7.1.1.1

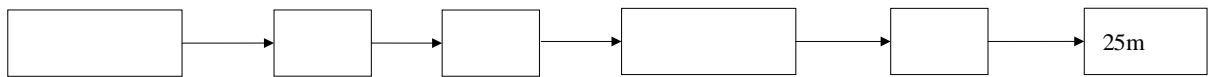

HJ-BAT-006

99.5%~99.9%

7.1.1.2

				25m
	HCl			30m
				27m
	HCl SO ₂ NO _x		+	40m
			1 1	12m

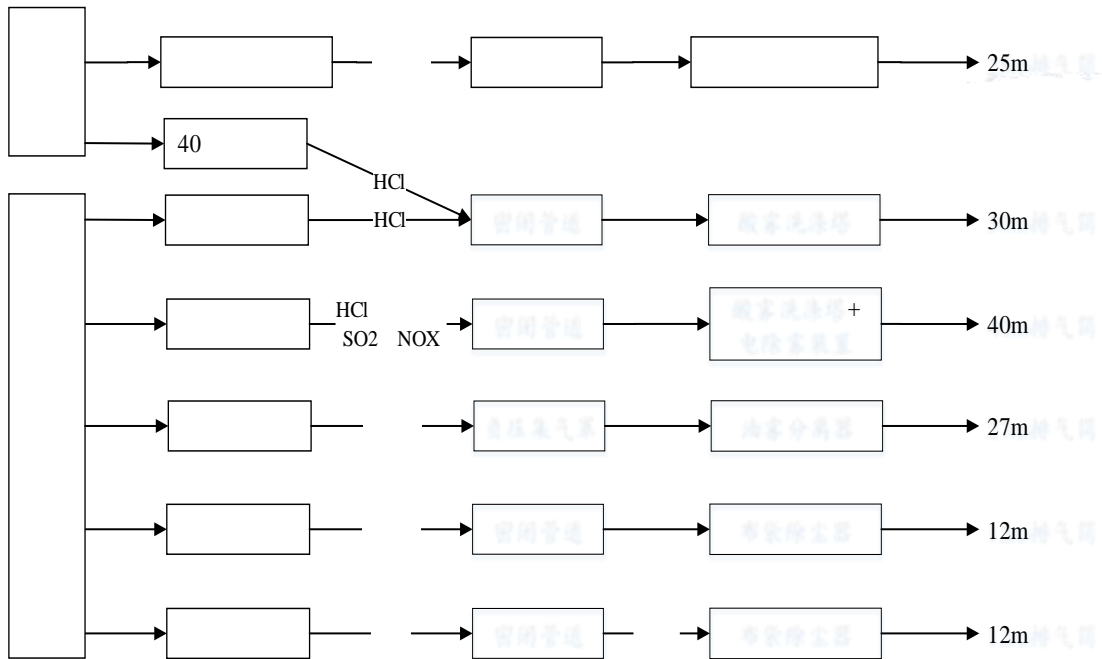

7.1.2

7.1.3

7.2

7.2.1

7.2.2

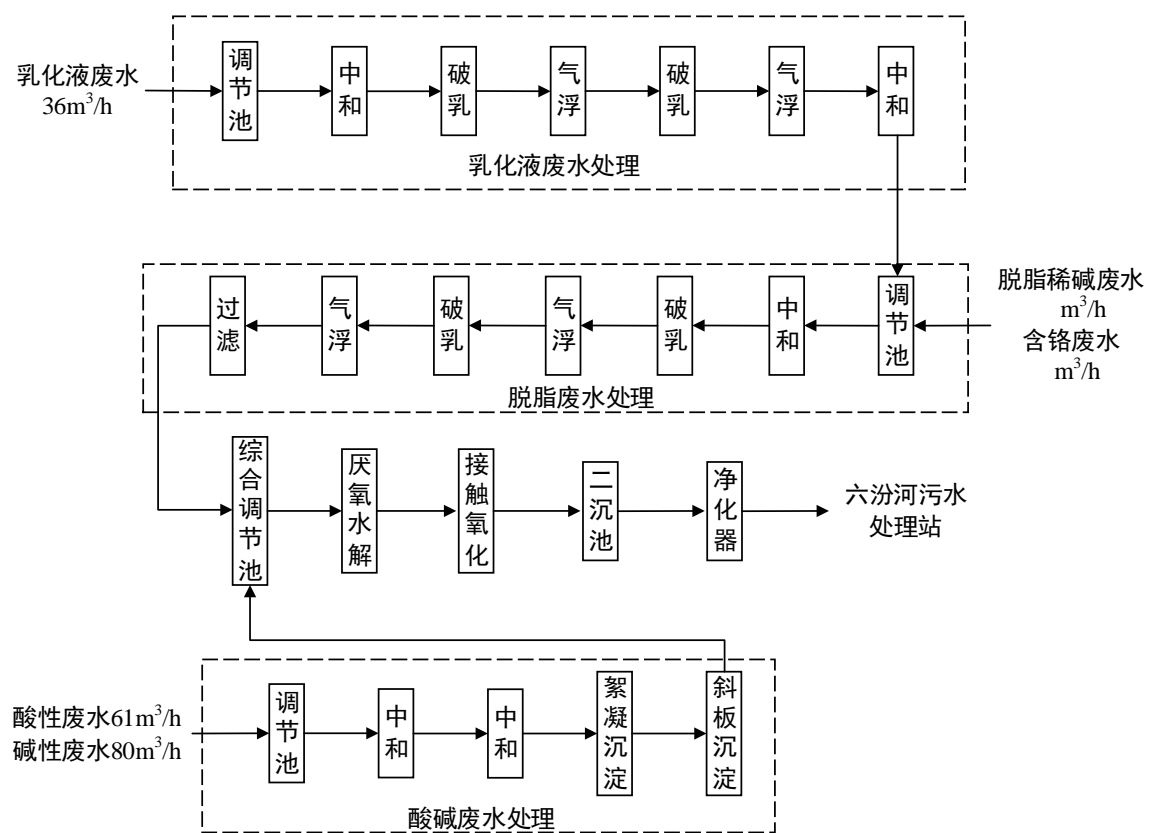

7.2.3

7.3

15dB(A)

7.4

7.4.1

7.4.2

7.4.3



7.5

7.5.1

"

"

7.5.2

"

"

"

"

"

"

"

"

7.5.3

7.5-1

	-			

-

⁻⁷ cm/s

⁻⁷ cm/s

8

8.1

8.2

8.3

8.3.1

8.3.2

9

9.1

9.1.1









9.1.2

9.1.3

9.1.4

" "

9.2

1			
2			
3			
4			
5			

9.3

	5# ()			+ +25m	0.8	0.081	0.634	GB28665-2012
	DA127	+40m ³ ()	HCl	+ +30m	12.2	0.183	1.424	
	DA125			+ +27m	5.3	1.066	8.316	
	DA126		HCl	+ +40m	20.7	0.393	3.065	
					3.8	0.071	0.556	
			SO ₂		35.7	0.678	5.29	
			NO _x		40.7	0.774	6.038	
	DA128			+ +12m	7.8	0.078	0.608	

9.4

9.5

9.5.1

	ZK04	pH Hg	1 1	GB/T14848-2017

9.5.2

			1 1	GB28665-2012
		HCl		
		HCl SO ₂ NO _x		
	1720	HCl		
		A		GB12348-2008

9.6 "

"

			301		
				GB13456-2012	
			+ +25m		25
	+40m ³	HCl	+ +30m		
			+ +27m		
			+ +12m		
	HCl SO ₂ NO _x		+ + +40m		

GB18599-2001

10

10.1

10.2

GB3096-2008

3

10.3



10.4

10.5

10.6

10.7

10.8

“ ”